

Type V Micro Switches

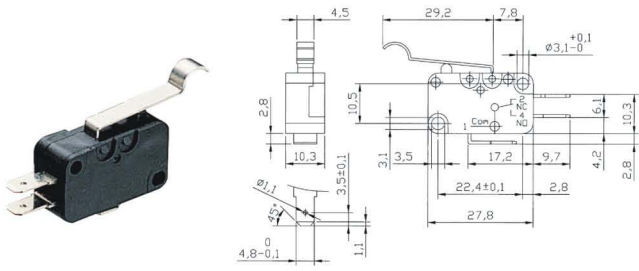

V15-187-04



V15-250-02

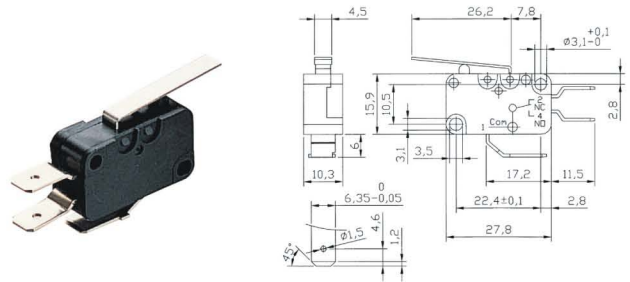

V15-187-05

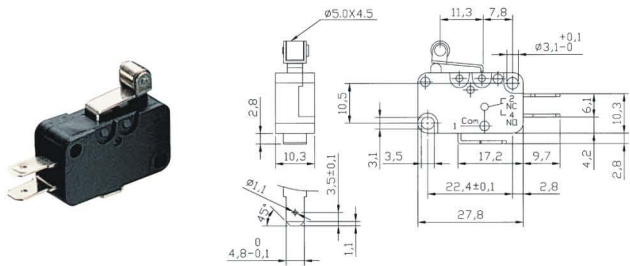

V15-250-03

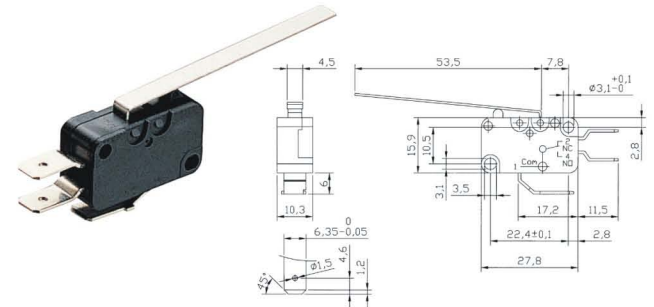

V15-187-06

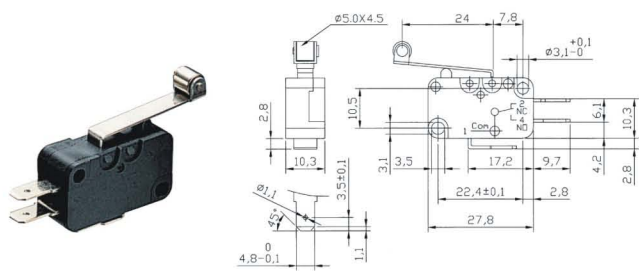

V15-250-04

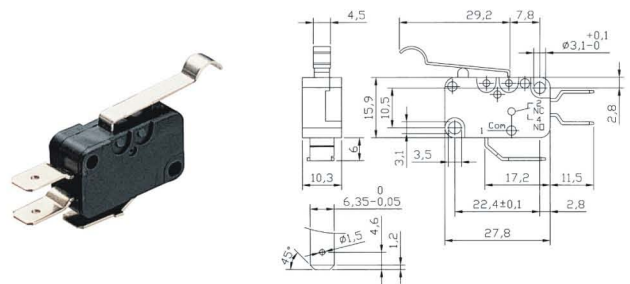

V15-250-00

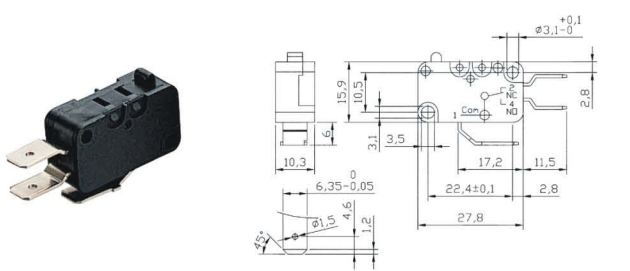

V15-250-05

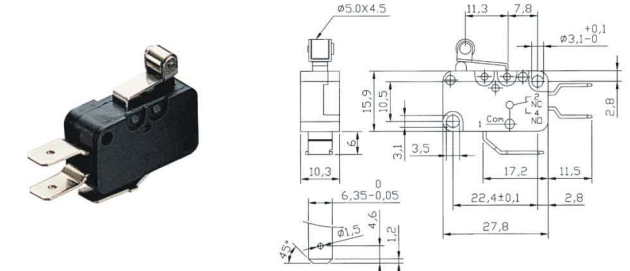

V15-250-01

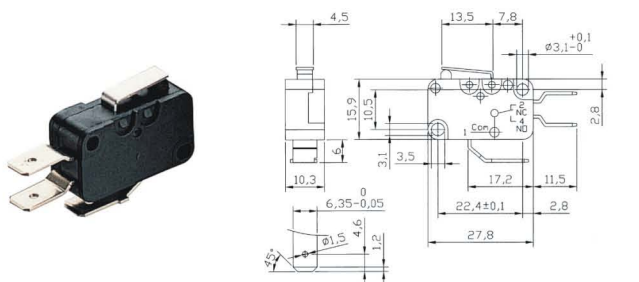

V15-250-06

